

Installationsanleitung
Seiteneinstiegleistenset (ISUZU D-MAX)
Installation Instruction
Kit Side Step (ISUZU D-MAX)

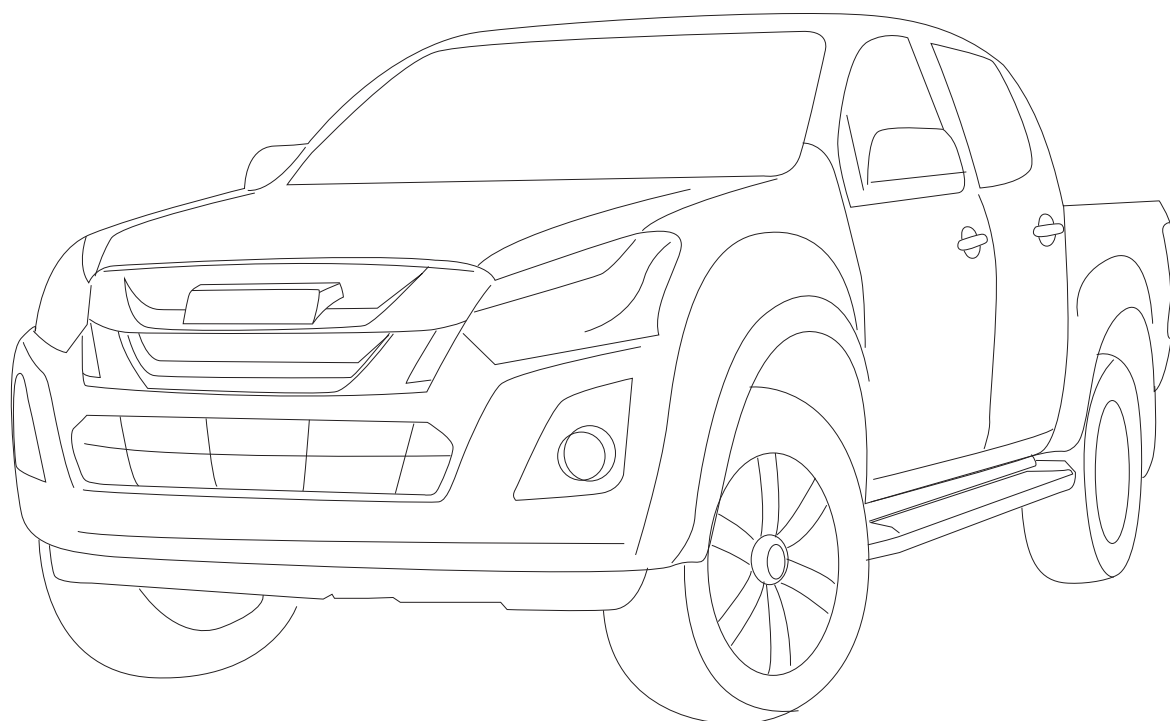

Für :
For : **ISUZU D-MAX**







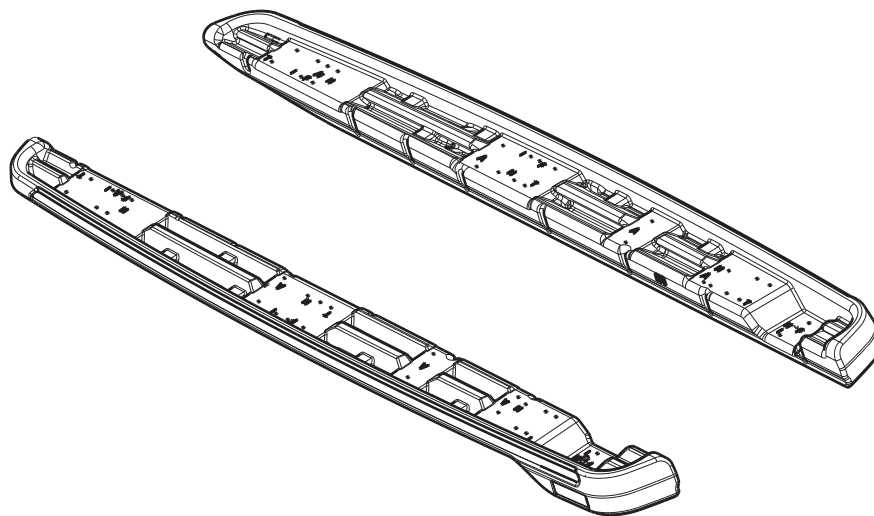

319113300002

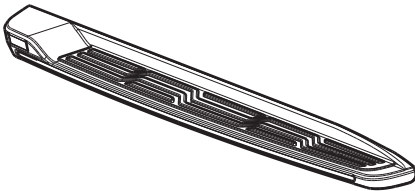
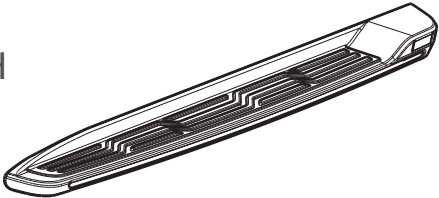
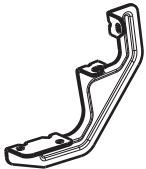
25/06/2018

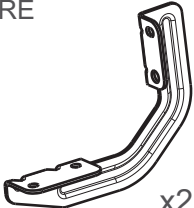
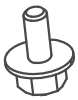
1/5



<p>A RE RH</p>  <p>x1</p>	<p>B LI LH</p>  <p>x1</p>			
<p>C FORNT COMMON LH/RH Vorne Allgemein LI/RE</p>  <p>x2</p>	<p>D MIDDLE COMMON LH/RH Mitte Allgemein LI/RE</p>  <p>x2</p>	<p>E REAR COMMON LH/RH Hinten Allgemein LI/RE</p>  <p>x2</p>		
<p>F M 6</p>  <p>X12</p>	<p>G M 8</p>  <p>X6</p>	<p>H M 8</p>  <p>X6</p>	<p>I</p>  <p>M 6 (washer) OD 16 mm M 6 (Unterlegscheibe) OD 16 mm X12</p>	<p>J</p>  <p>M 8 (washer) OD 22 mm M 8 (Unterlegscheibe) OD 22 mm X6</p>

1

Mit Fahrzeugschrauben
With Vehicle Screw

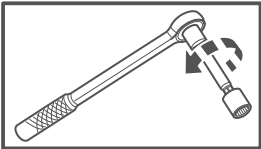
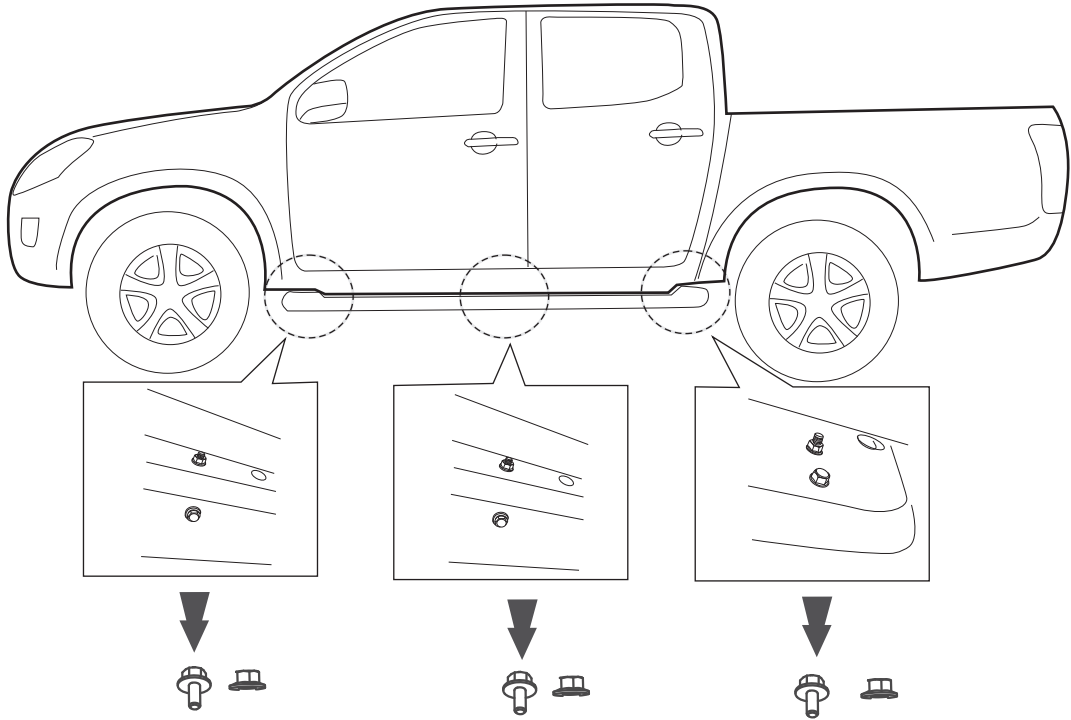

X6
Pro Seite / Per Side

Ohne Fahrzeugschrauben
Without Vehicle Screw

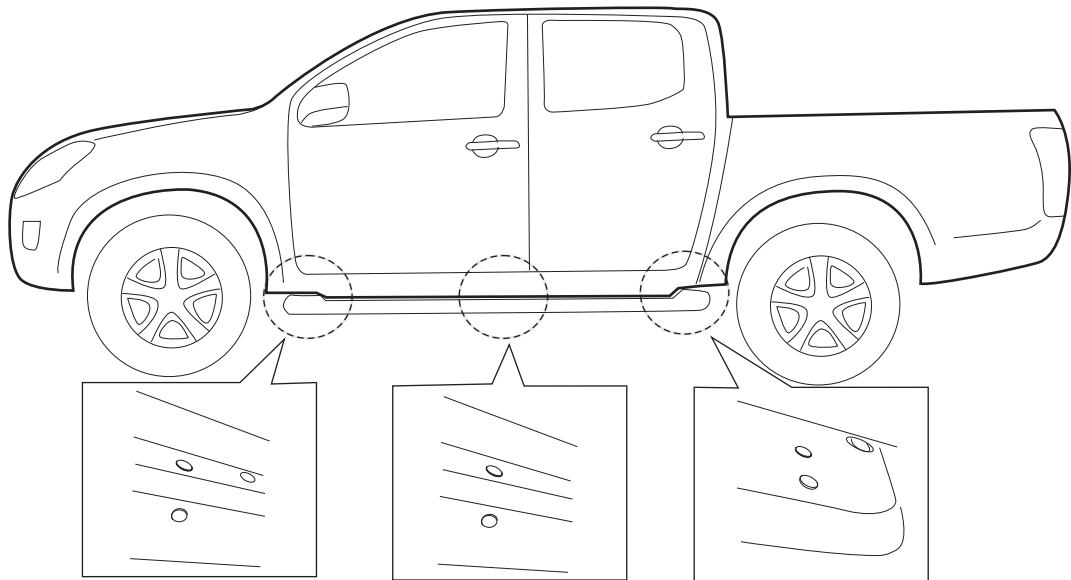

2

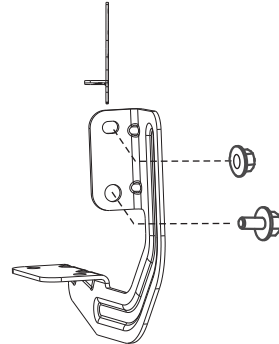
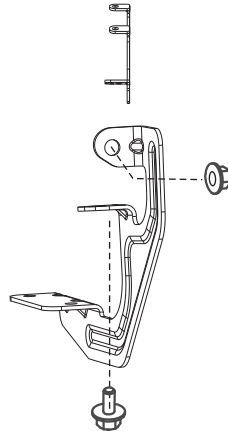
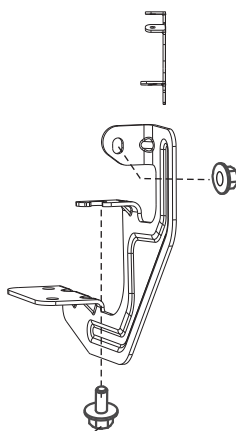
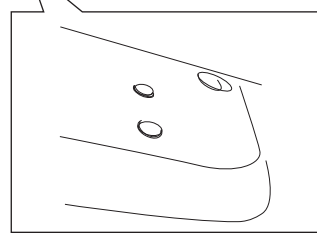
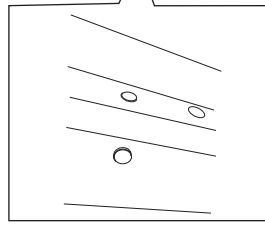
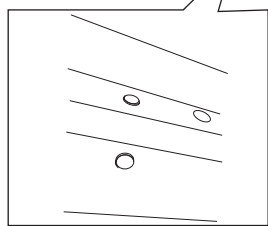
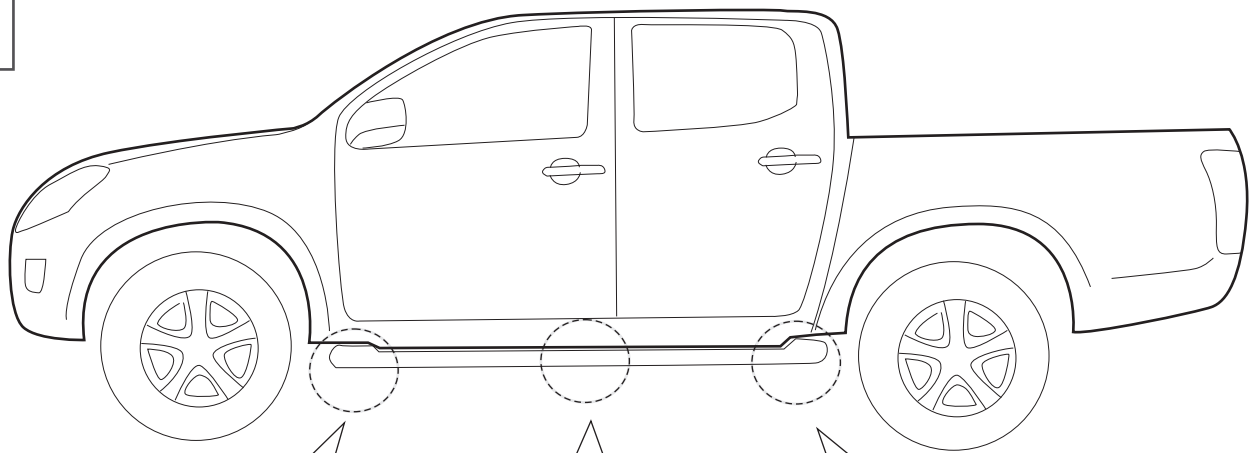

Fahrzeugschrauben
Vehicle screw

Mit Fahrzeugschrauben
With vehicle screw

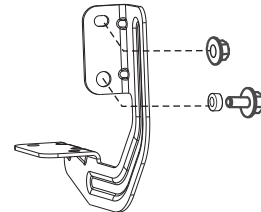
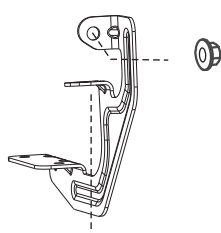
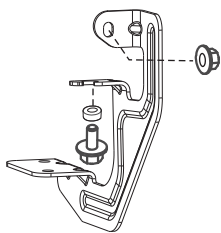

Unterlegscheibe OD 22 mm x 6 Pcs
Washer OD 22 mm x 6 Pcs (Für RE / LI)
Schraube M8
Screw M8 x 6 Pcs (Für RE / LI)

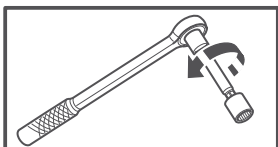

12.5 Nm.

X6
Pro Seite / Per Side

Ohne Fahrzeugschrauben
Without vehicle screw

3

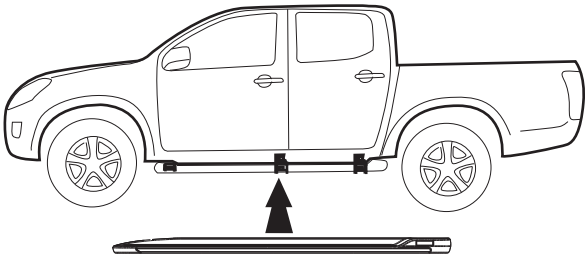

Achten Sie darauf, die Lackierung nicht zu beschädigen
Ziehen Sie die lose Schrauben zwischen den Halterungen
und Fahrzeug für jede Position der Halterung fest



BE CAREFUL NOT TO DAMAGE THE PAINT WORK
TIGHTEN LOOSE SCREW BETWEEN BRACKET
AND VEHICLE FOR EACH POSITION OF BRACKET

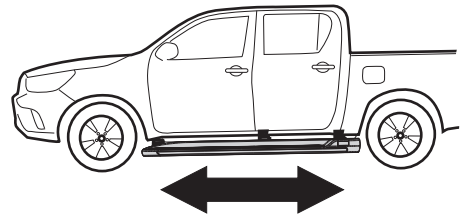

Seitenstufe auf Lochposition anpassen
ADJUST SIDE STEP FOR ISUZU HOLE POSITION

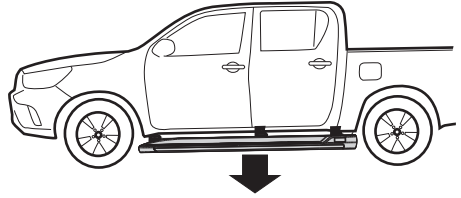

Fixiere die Seitenleiste in Pfeilrichtung der Langlöcher
FIX SIDE STEP SCREWS AT THE ARROW DIRECTION END OF SLOT HOLES.

Achtung : Fahrzeug Seitenleiste ist links und rechts spiegelgleich

NOTE : VEHICLE NOT SHOWN FOR CLARITY
LHS SHOWN RHS SYMETRICALLY OPPOSITE

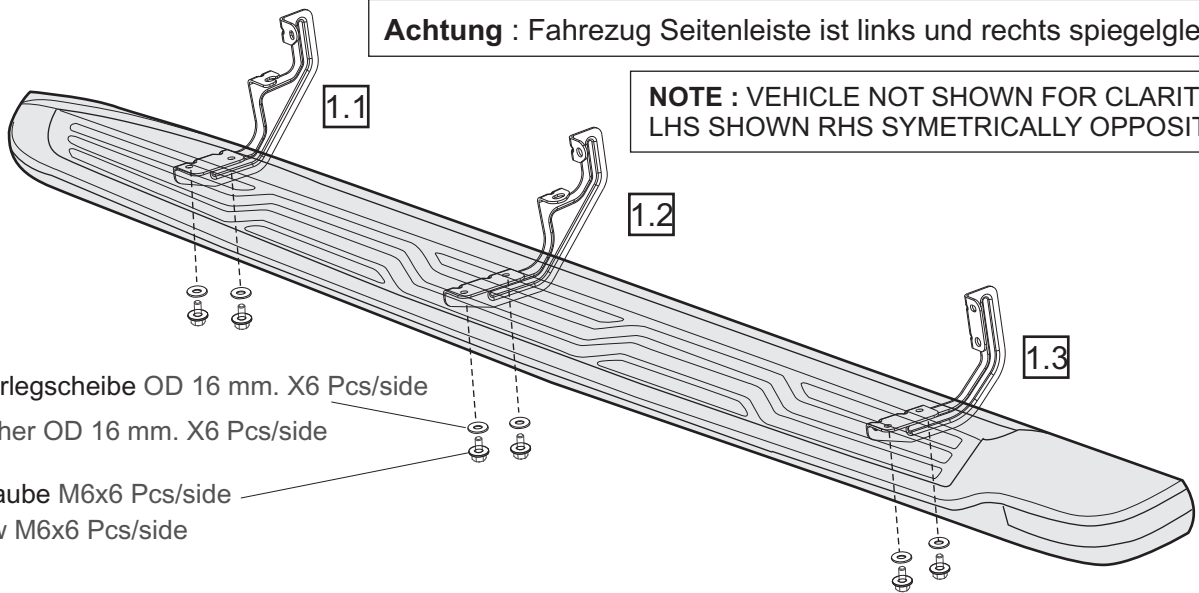

Unterlegscheibe OD 16 mm. X6 Pcs/side

Washer OD 16 mm. X6 Pcs/side

Schraube M6x6 Pcs/side

Screw M6x6 Pcs/side

- REMARK :** 1.) Nach Anpassen der Seitenleiste an den Löchern,
die Schrauben der Klemme und Seitenleiste anziehen
2.) Alle Schrauben anziehen
3.) Film von der Chromleiste entfernen

- REMARK :** 1.) AFTER ADJUST SIDE STEP FOR TOYOTA HOLE THEN
TIGHTEN LOOSE SCREW BETWEEN BRACKET AND SIDE STEP
2.) TIGHTEN SCREW FOR ALL POSITION
3.) FINALLY PLEASE PEE; CLEAR FILM OFF FROM PVC CHROME STRIP.

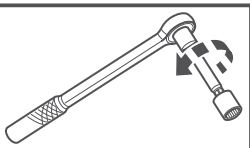

8 Nm

X6

Pro Seite / Per Side

1.1

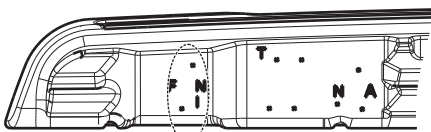

ISUZU

1.2

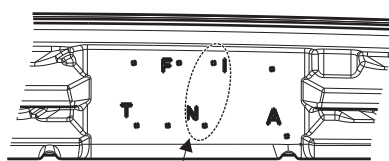

ISUZU

1.3

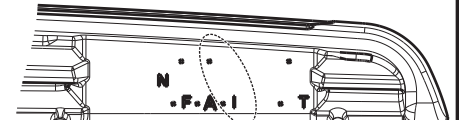

ISUZU